



B2/1, B3/1, B4/1

EHN,EHV



EZN,EZV

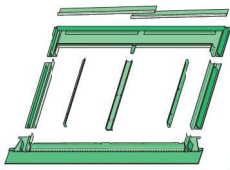
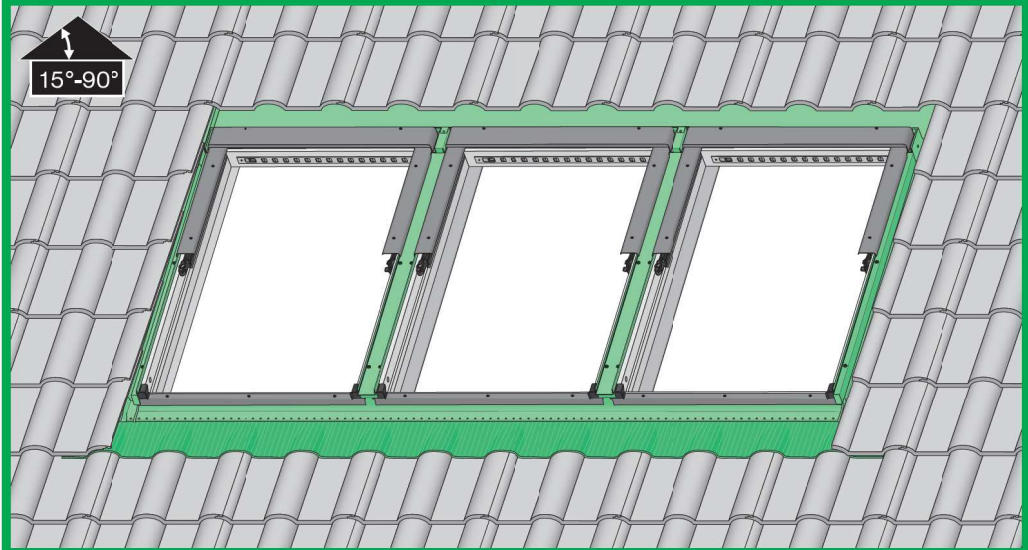
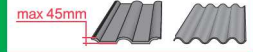

B2/1

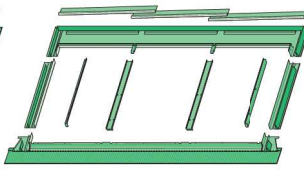

B3/1

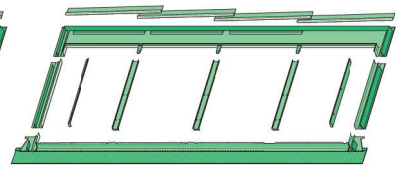

B4/1

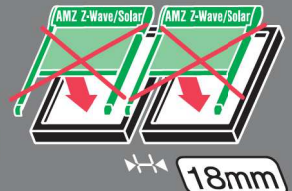

B3/1 FTP-V EZV

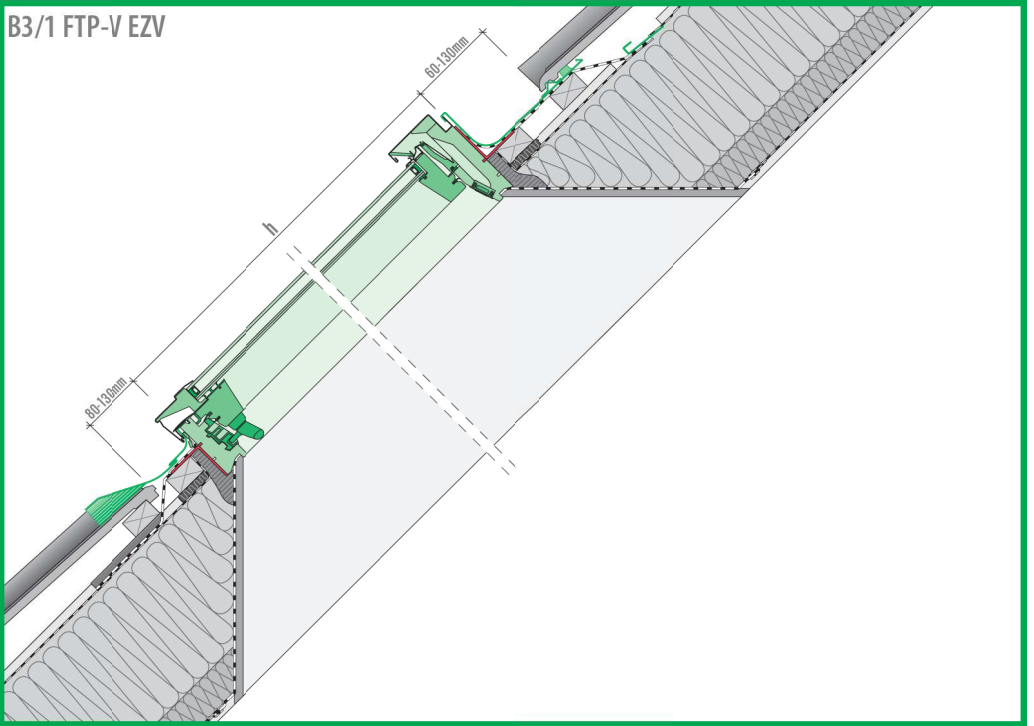

B3/1 FTP-V EZV

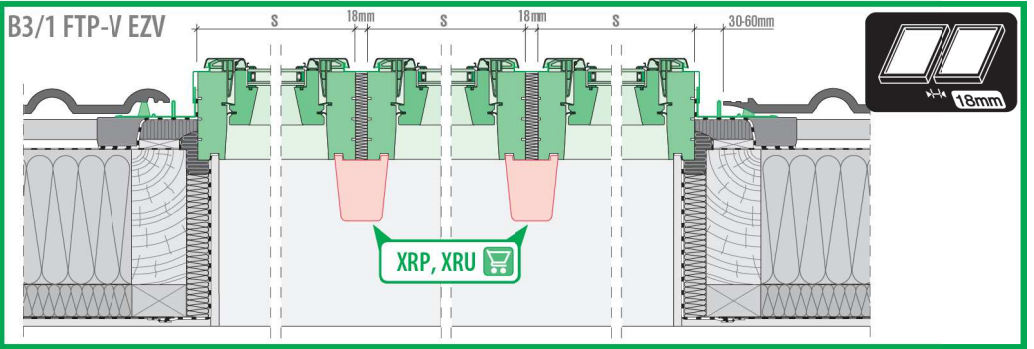

B3/1 FTP-V EZV

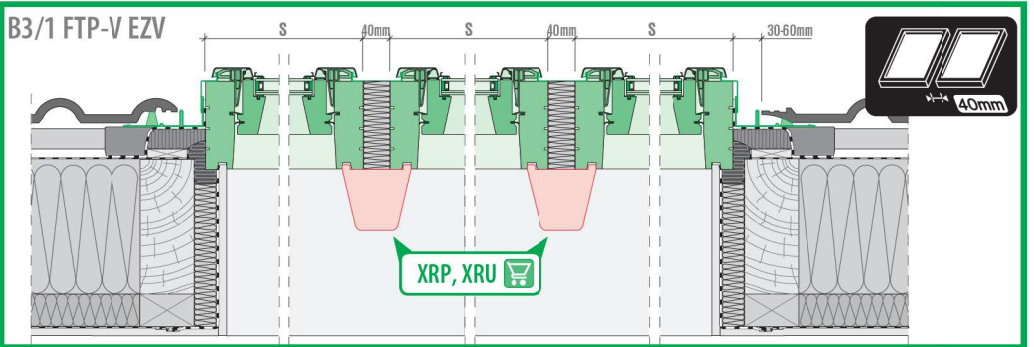

EHN, EHV

EZN, EZV

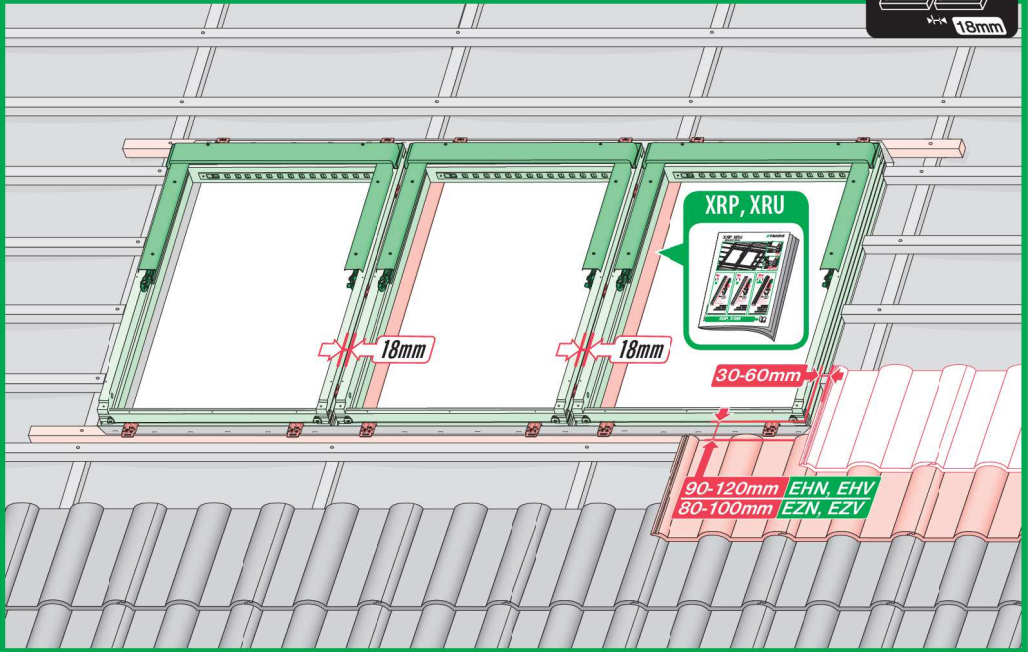

EHN, EHV

EZN, EZV

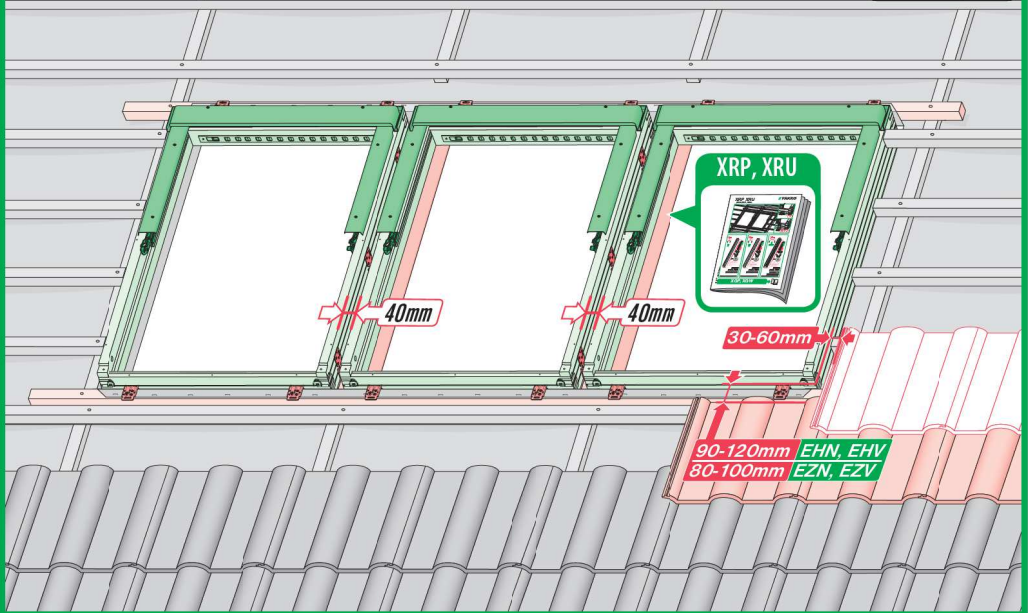



T20
PZ2

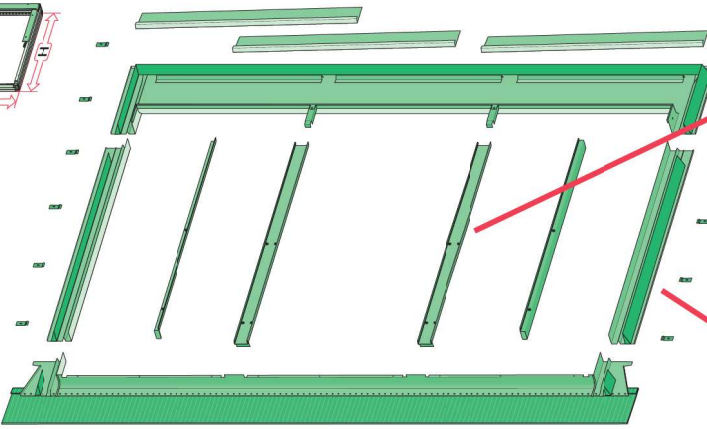
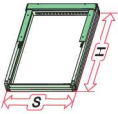
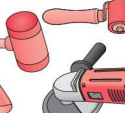
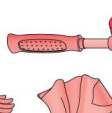
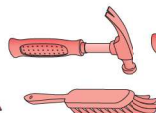
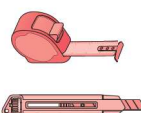

H≤186cm H>186cm

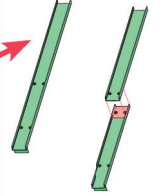

H≤186cm H>186cm

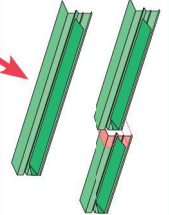

T20

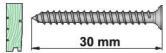

30 mm

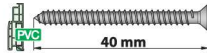

40 mm

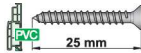

25 mm



25 mm

1a

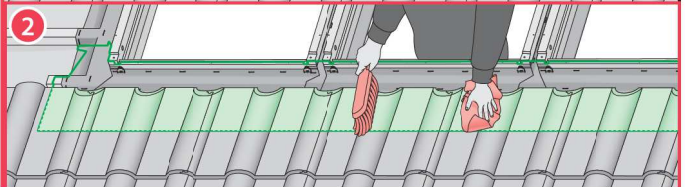
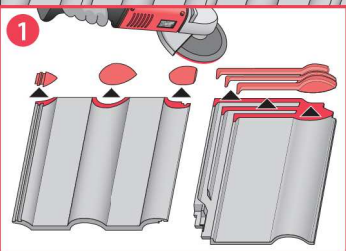
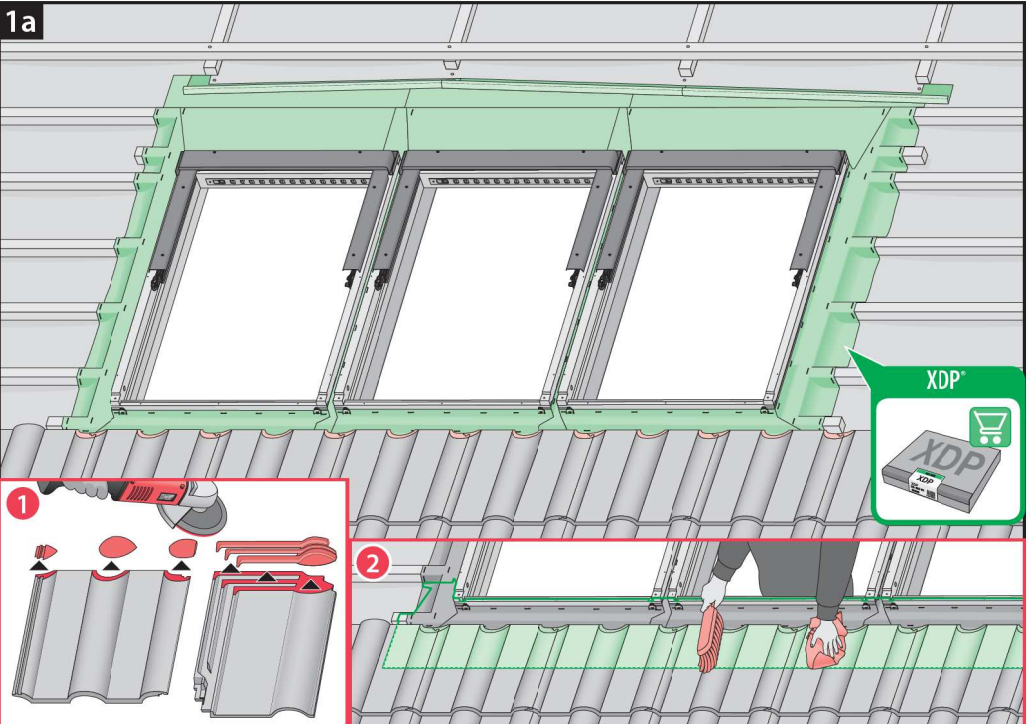

XDP®



1b

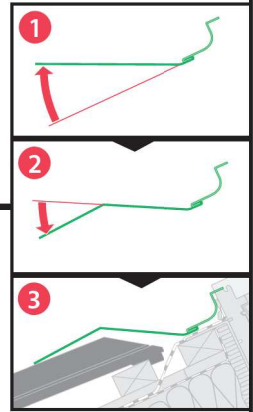
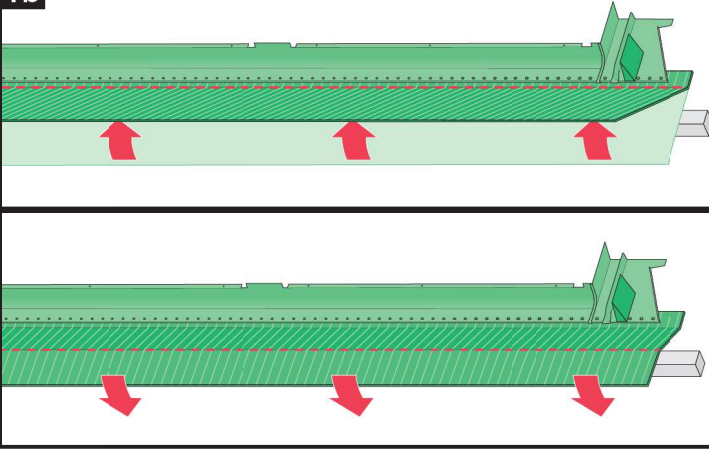

1c

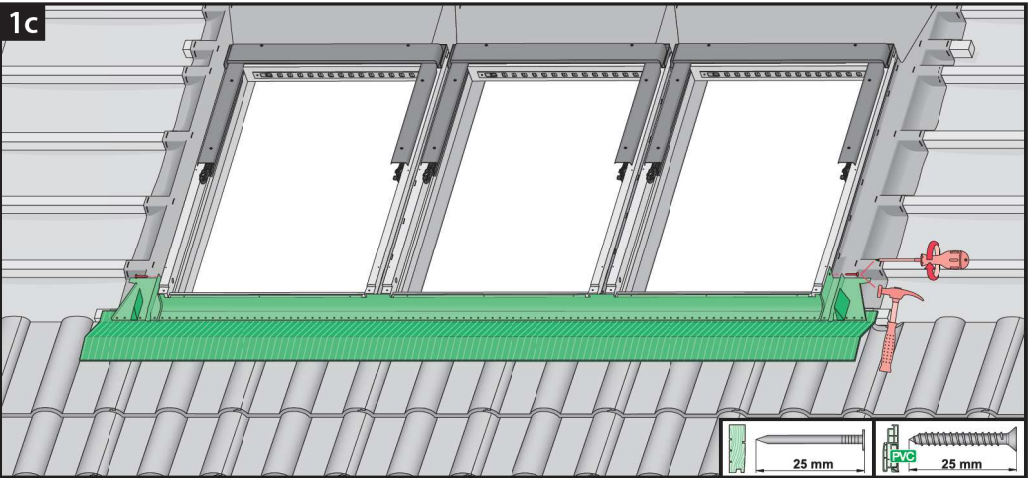

1c*

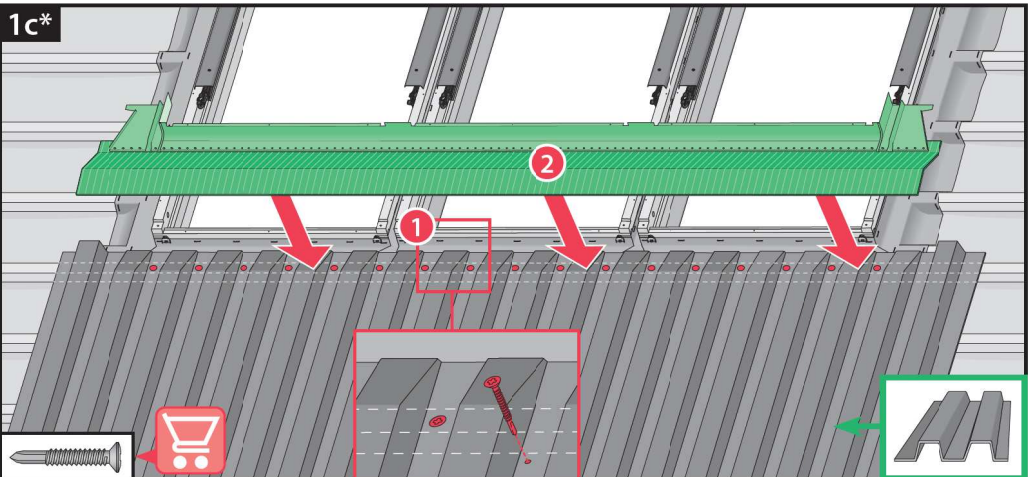

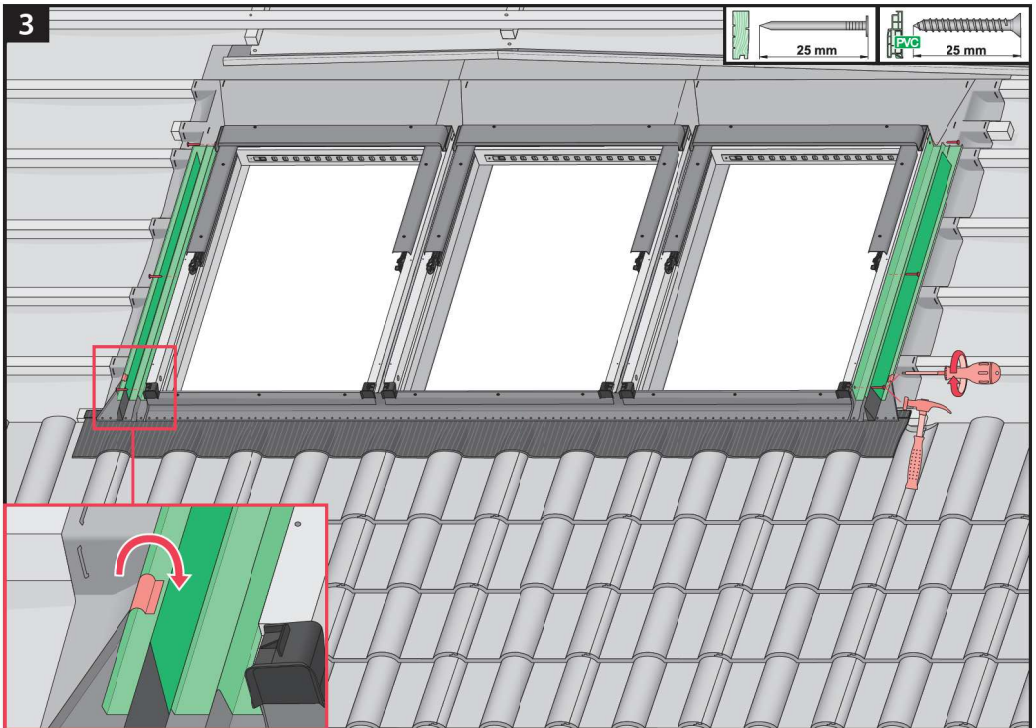
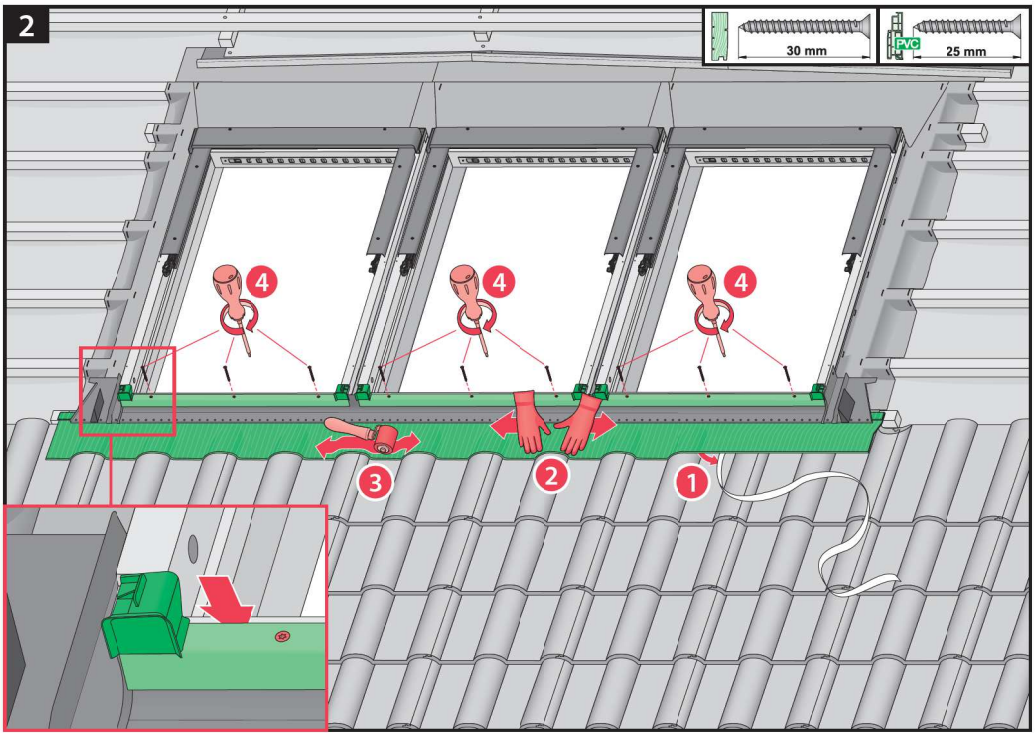

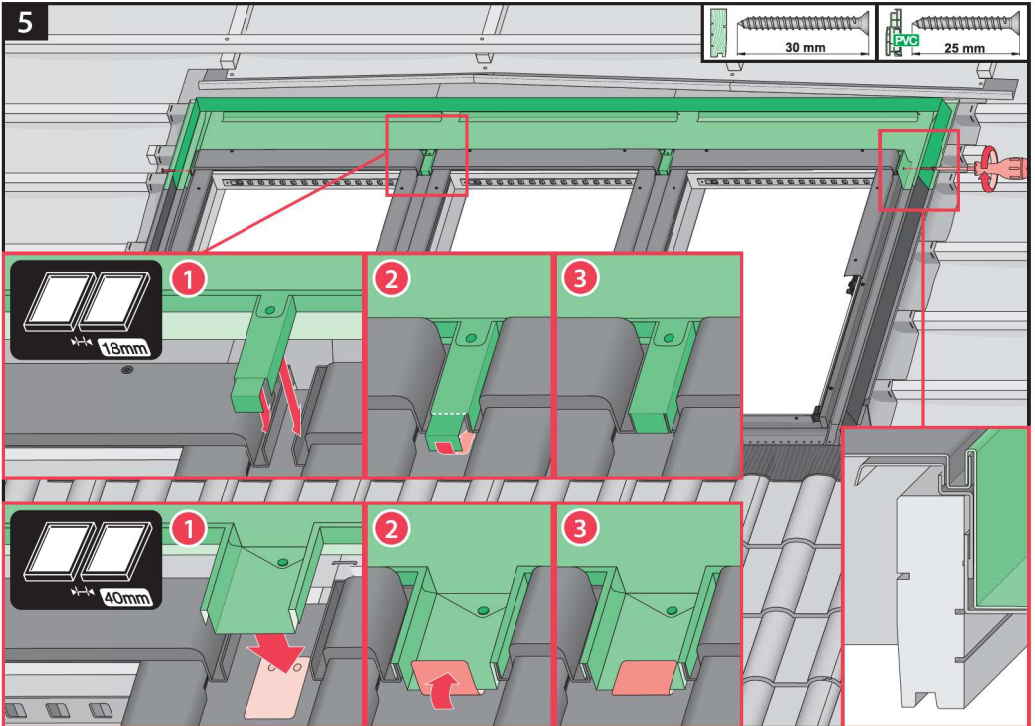
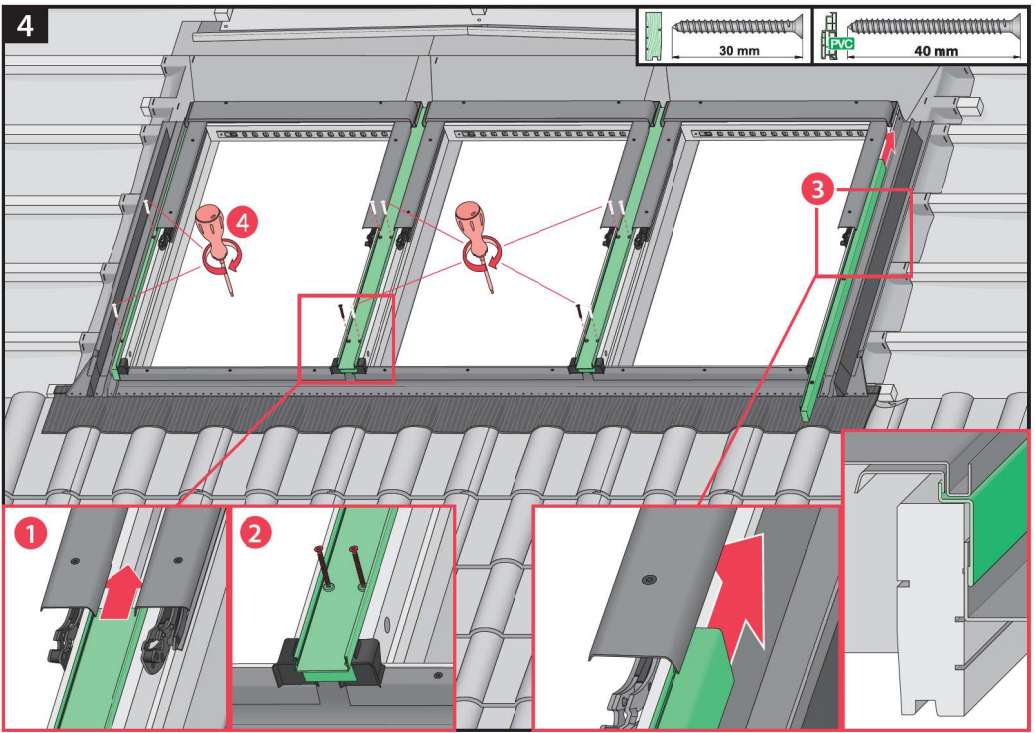

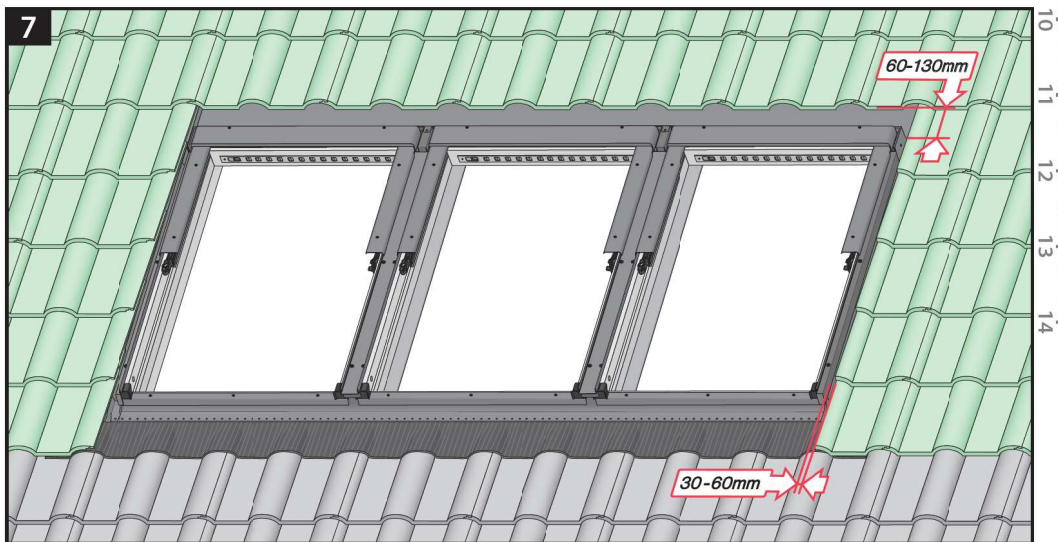
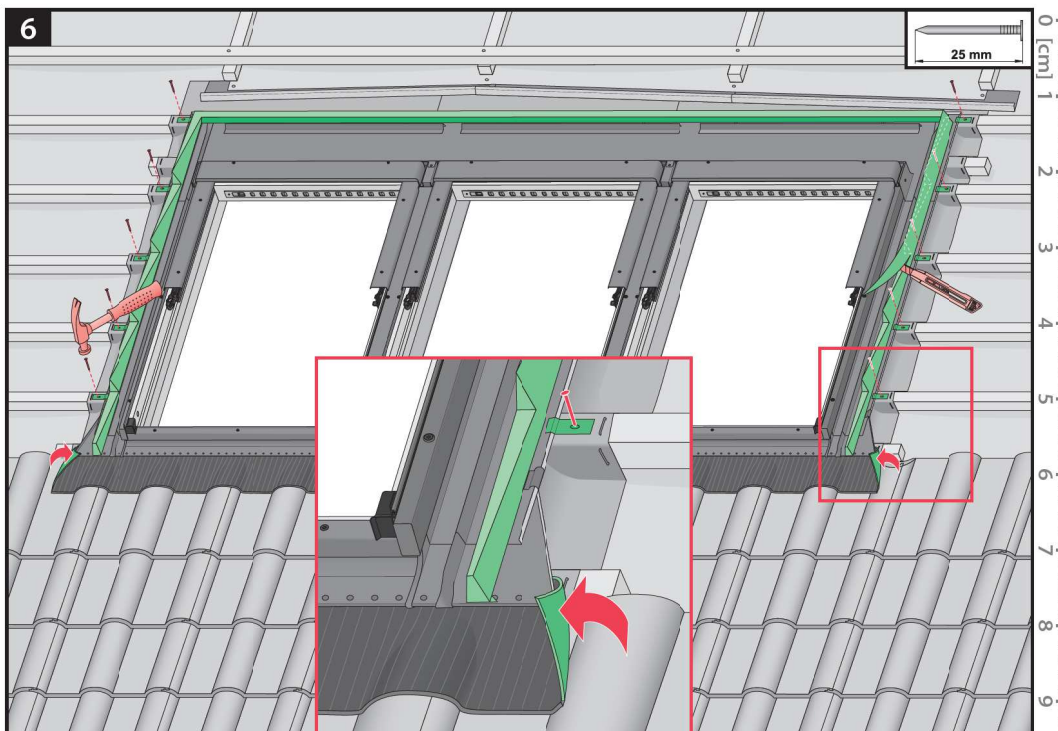

CZ Výrobce ani prodejce nenosí žádnou odpovědnost za nedodržení příslušných platných zákonů, stavebních předpisů a bezpečnostních požadavků uživatelem výrobku, architektem, montážníkem nebo vlastním objektem.

ES El fabricante y el vendedor no tienen ninguna responsabilidad por el incumplimiento de la ley vigente, normas de construcción y exigencias de seguridad por parte del usuario del producto, arquitecto, instalador o el propietario del edificio.

GB Manufacturer and Seller shall bear no liability for failure to comply with the applicable laws, building codes and safety requirements by the user of the product, architect, fitter or owner of the building.

IT Il Produttore e il Rivenditore non potranno essere ritenuti responsabili per il mancato rispetto, da parte dell'utente del prodotto, del progettista, dell'installatore o del proprietario dell'edificio, delle leggi vigenti, norme di regolamenti edilizi e di quelli relativi alla sicurezza.

PL Producent i sprzedawca nie ponosi żadnej odpowiedzialności za nieprzestrzeganie stosownych przepisów prawa, przepisów budowlanych i wymogów bezpieczeństwa przez użytkownika produktu, architekta, montażystę lub właściciela budynku.

RO Nici producătorul, nici distribuitorul nu sîi vor asuma niciun fel de rîspundere pentru nerespectarea legilor în vigoare, a legilor din domeniul construcțiilor sau a măsurilor de siguranță impuse utilizatorului produsului, arhitectului, montajistului sau proprietarilor clădirii.

RU Уточка а продавца не несет ответственности за нарушение применимых законов, строительных предписов а безопасности требований заказчика к изделию, архитектором, монтажником или владельцем здания строительных правил и норм безопасности и ответственности производителя и продавца снимаются.

SK

DE Hersteller und Verkäufer übernehmen keine Haftung für Nichtbeachtung entsprechender rechts- und Bauvorschriften sowie Sicherheitsanforderungen seitens Produktbenutzers, Architekten, Monteure oder Gebäudebesitzer.

FR Le fabricant et le vendeur ne prend aucune responsabilité de ne pas respecter les lois applicables, les règlements sur les bâtiments et les exigences de sécurité par l'utilisateur du produit, l'architecte, l'installateur ou le propriétaire du bâtiment.

HU A Gyártó és a Forgalmazó nem vállal semmiféle felelősséget a vonatkozó törvényi, építési és biztonsági előírások teremtéshasznló, építész, telepítőmester vagy épületajdonos általi be nem tartásáért.

NL De fabrikant en verkoper zijn niet aansprakelijk voor gevolgen bij het niet opvolgen van toepasselijke wetten, bouwbesluiten en veiligheidsvoorschriften door de gebruiker van het product, de architect, de installateur of de eigenaar van het gebouw.

PT O fabricante e o vendedor não tem nenhuma responsabilidade pelo o não cumprimento da lei, códigos de construção e as exigências de segurança por parte do usuário do produto, arquiteto, instalador ou proprietário do edifício.

RU В случае несоблюдения архитектором, монтажником или владельцем здания строительных правил и норм безопасности и ответственности производителя и продавца снимаются.